

User Manual

-Installation

-Operation

SMP300

SMP600

Omnik New Energy Co.,Ltd.

CONTENTS

1. Introduction	3
2. Safety	3
2.1. Symbol illustration	3
2.2. Installation warnings	4
3. Product Description.....	6
4. Technical data.....	7
5. Prepare for installing.....	8
5.1. Transport and inspect.....	8
5.2. Check installation environment	8
5.3. Installation position.....	8
6. Mounting and wiring.....	9
6.1. Install one Micro-inverter	9
6.1.1. Installing diagram.....	9
6.1.2. Assembly instruction	10
Step 1. Install Micro-inverter	10
Step 2. Connecting AC End Cables	13
Step 3. Install Photovoltaic Modules	16
6.2. Install Several Micro-inverters	17
6.2.1. Installing diagram.....	17
6.2.2. Assembly instruction	18
Step 1. Install Micro-inverter	18
Step 2. Install AC Junction Box.....	21
Step 3. Connect AC Cable of Micro-inverter.....	21
Step 4. Connecting AC End Cables to Junction Box	22
Step 5. Create an Installation Map	24
Step 6. Install Photovoltaic Modules	26
Step 7. Energize the System.....	27
7. Maintenance guide.....	27
7.1. Routine maintenance	27
7.2. Storage and dismantling	28
8. Contact Information.....	28
Appendix : TEMPLATE FOR MAP OF MICRO-INVERTER INSTALLATION	29

1. Introduction

Thank you for using SMP300/600 Micro-Inverter! This Micro-Inverter system is the world's most technologically advanced inverter system with benefits of efficient, flexible, safe and reliable for use in utility-interactive applications.

This system is composed of a group of Micro-inverters that convert direct current (DC) into alternating current (AC) and feeds it into the electric grid. Different from systems that photovoltaic modules are subdivided into strings and controlled by one or several inverters, this system is built for the incorporation of a Micro-inverter for each photovoltaic module. Each Micro-inverter works independently of the others to guarantee maximum power of each photovoltaic module. This setup enables direct control over the production of as single photovoltaic module, consequently improving the flexibility and reliability of the system.

This manual contains important instructions for the SMP300/600 Micro-inverter and must be read in its entirety before installing or commissioning the equipment. For safety, only qualified technician, who has received training or has demonstrated skills can install and maintain this Micro-inverter under the guide of this document.



2. Safety

IMPORTANT SAFETY INSTRUCTIONS!





PLEASE KEEP THIS INTRODUCTION IN A SAFE PLACE!

2.1.Symbol illustration

The safety symbols used in this manual are list below and illustrated in detail.

Symbol	Usage
	Indicates a hazardous situation that can result in deadly electric shock hazards, other serious physical injury, or fire hazards.
	Indicates directions which must be fully understood and followed in entirety in order to avoid potential safety hazards including equipment damage or personal injury.
	This points out that the described operation must not be carried out. The reader should stop, use caution and fully understand the operations explained before proceeding.

The symbols on the micro-inverter are list below and illustrated in detail.

Symbol	Usage
	<p>Treatment</p> <p>To comply with European Directive 2012/19/EU on waste Electrical and Electronic Equipment and its implementation as national law, electrical equipment that has reached the end of its life must be collected separately and returned to an approved recycling facility. Any device no longer required must be returned to an authorized dealer or approved collection and recycling facility.</p>
	<p>Caution</p> <p>Do not come within 8 inches (20cm) of the micro-inverter for any length of time while it is in operation.</p>
	<p>Danger of high voltages</p> <p>Danger to life due to high voltage in the micro-inverter.</p>
	<p>Beware of hot surface</p> <p>The inverter can become hot during operation. Avoid contact with metal surfaces during operation.</p>
	<p>CE mark</p> <p>The inverter complies with the requirements of the Low Voltage Directive for the European Union.</p>
	<p>Read manual first</p> <p>Please read the installation manual first before installation, operation and maintenance.</p>

2.2. Installation warnings

The SMP300/600 Micro-inverter is designed and tested according to international safety requirements. However, certain safety precautions must be taken when installing and operating this inverter. The installer must read and follow all instructions, cautions and warnings in this installation manual



	➤ All operations including transport, installation, start-up and maintenance, must be carried out by qualified, trained personnel.
	➤ Before installation, check the unit to ensure absence of any transport or handling damage, which could affect insulation integrity or safety clearances. Choose installation location carefully and adhere to specified cooling requirements. Unauthorized removal of necessary protections, improper use, incorrect installation and operation may lead to serious safety and shock hazards or equipment damage.
	➤ Before connecting the Micro-inverter to the power distribution grid, contact the local power distribution grid company to get appropriate approvals. This connection must be made only by qualified technical personnel .It is the responsibility of the installer to provide external disconnects switches and Over current Protection Devices (OCPD).
	➤ When the photovoltaic array is exposed to light, it supplies a D.C. voltage to the inverter
	➤ Only one photovoltaic module can be connected in the input of the inverter. Do not connect batteries or other sources of power supply. The inverter can be used only if all the technical characteristics are observed and applied.
	➤ Do not install the equipment in adverse environment conditions such as flammable, explosive, corrosive, extreme high or low temperature, and humid. Do not use the equipment when the safety devices do not work or disabled.
	➤ Use personal protective equipment, including gloves and eye protection when working.
	➤ Inform the manufacturer about non-standard installation conditions.
	➤ Do not use the equipment if any operating anomalies are found. Avoid temporary repairs.
	➤ All repairs should be carried out using only qualified spare parts, which must be installed in accordance with their intended use and by a licensed contractor or authorized Omnik service representative.
	➤ Liabilities arising from commercial components are delegated to their respective manufacturers.
	➤ Anytime the inverter has been disconnected from the power network, use extreme caution as some components can retain charge sufficient to create a shock hazard. Prior to touching any part of the inverter use care to ensure surfaces and equipment are at touch safe temperatures and voltage potentials before proceeding.
	➤ Omnik accepts No liability for damage from incorrect or careless operation
	➤ Electrical Installation & Maintenance shall be conducted by licensed electrician and shall comply with Australia National Wiring Rules

3. Product Description

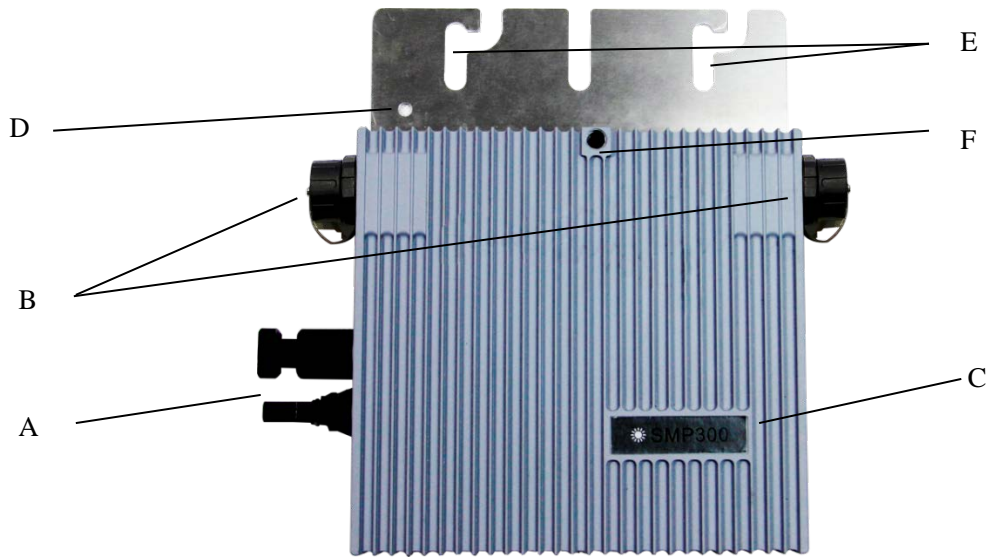

Fig.1. SMP300

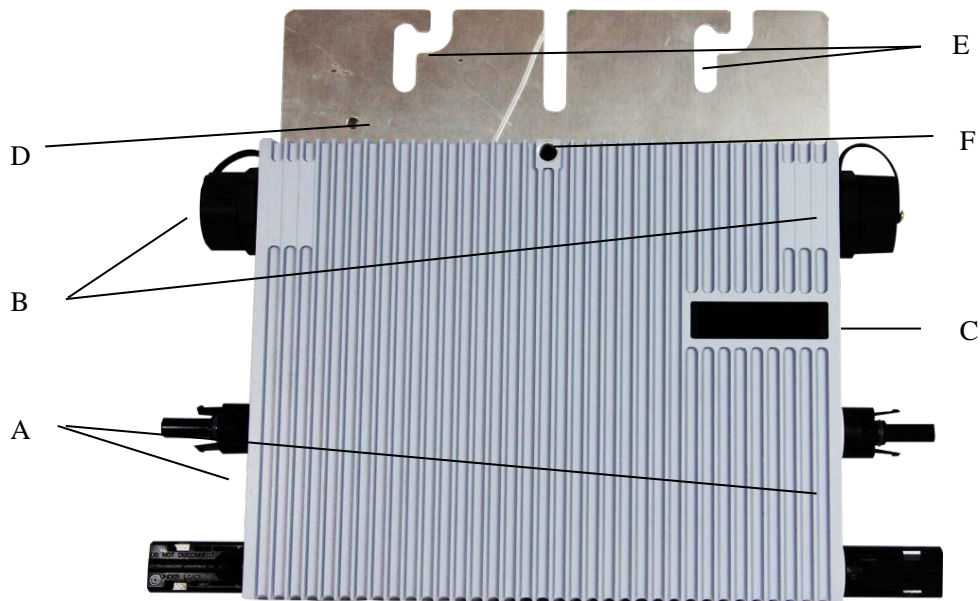

Fig.2. SMP600

Item	Description
A	DC connectors
B	AC connector
C	LED
D	Grounding hole
E	Wall bracket hole
F	Quick install hole

4. Technical data

Model	SMP300	SMP600
Input data(DC)		
Recommended input power (W)	200~320	2 * 200~320
MPPT voltage range (V)	24~45	24~45
Operating voltage range (V)	18~50	18~50
Maximum input voltage (V)	50	50
Maximum input current (A)	9.5	9.5
Inverter back feed current (A)	0	0
Max. Input Short Circuit Current (A)	15	15
Output Data (AC)		
Max. output power (W)	270	550
Rated output power (W)	250	500
Rated output current (A)	1.09	2.17
Max. output current (A)	1.19	2.39
Maximum output fault current [A]	1.5	3
Maximum output protection current [A]	20	20
Nominal output voltage (V)	220/230/240	220/230/240
Nominal frequency (Hz)	50/60	50/60
Power factor	>0.99	>0.99
Output current harmonic distortion	<3%	<3%
Maximum Units per 20A Branch	16	8
Efficiency		
Peak inverter efficiency	96.7%	96.7%
CEC weighted efficiency	96.5%	96.5%
Nominal MPPT efficiency	99.8%	99.8%
Night time power consumption (mW)	<120	<120
Mechanical Data		
Dimensions (W×H×D mm)	168×162×34.5	218×174×34.5
Weight [kg]	1.89	2.35
Type of Enclosure	IP67	
Cooling	Natural Convection	
Environmental Data		
Operating Ambient Temperature Range	-40°C to 65°C	
Operating Internal Temperature Range	-40°C to 85°C	
Relative Humidity	0-100 % condensing	
Environmental Category Rating	Outdoor, suitable to wet locations	
Isolation Type	Isolation Transformer	
Insulation Level	Reinforced insulation	
Max. Operating Altitude without Derating [m]	2000	
Pollution Degree	PD2	

Overvoltage Category	OVC II for PV input circuit, OVC III for mains circuit
Protective class	I

5. Prepare for installing

5.1. Transport and inspect

Omnik packages and protects individual components using suitable means to make the transport and subsequent handling easier. Transportation of the equipment, especially by road, must be carried out by suitable ways for protecting the components (in particular, the electronic components) from violent, shocks, humidity, vibration, etc. Please dispose the packaging elements in appropriate ways to avoid unforeseen injury.

It is the customer's responsibility to examine the condition of the components transported. Once receiving the Micro-inverter, it is necessary to check the container for any external damage and verify receipt of all items. Call the delivering carrier immediately if damage or shortage is detected .If inspection reveals damage to the inverter, contact the supplier, or authorized distributor for are pair/return determination and instructions regarding the process.

5.2. Check installation environment

Installation of the equipment is carried out based on the system design and the place in which the equipment is installed.

- The installation must be carried out with the equipment disconnected from the grid(power disconnect switch open) and with the photovoltaic modules shaded or isolated.
- To avoid unwanted power derating due to an increase in the internal temperature of the inverter, do not expose it to direct sunlight.
- To avoid overheating, always make sure the flow of air around the inverter is not blocked.
- Do not install in places where gasses or flammable substances may be present.
- Avoid electromagnetic interference that can compromise the correct operation of electronic equipment.
- To ensure the safety of personnel and equipment needed to mount the PV array is connected and grounded with other conductor casing.

5.3. Installation position

When choosing the position of installation, comply with the following conditions:

Install only on structures specifically conceived for photovoltaic modules (supplied by installation technicians).

Install Micro-inverter underneath the photovoltaic modules so that they work in the shade.

If this condition cannot be met, the inverter could undergo derating.

6. Mounting and wiring

6.1. Install one Micro-inverter

6.1.1. Installing diagram

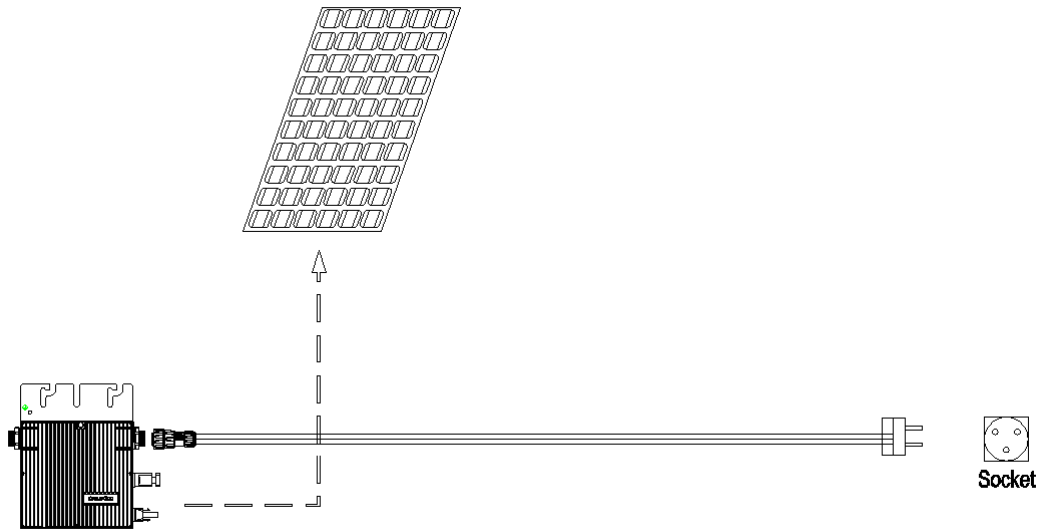

Fig.3. Assembly Illustration (Only one SMP300)

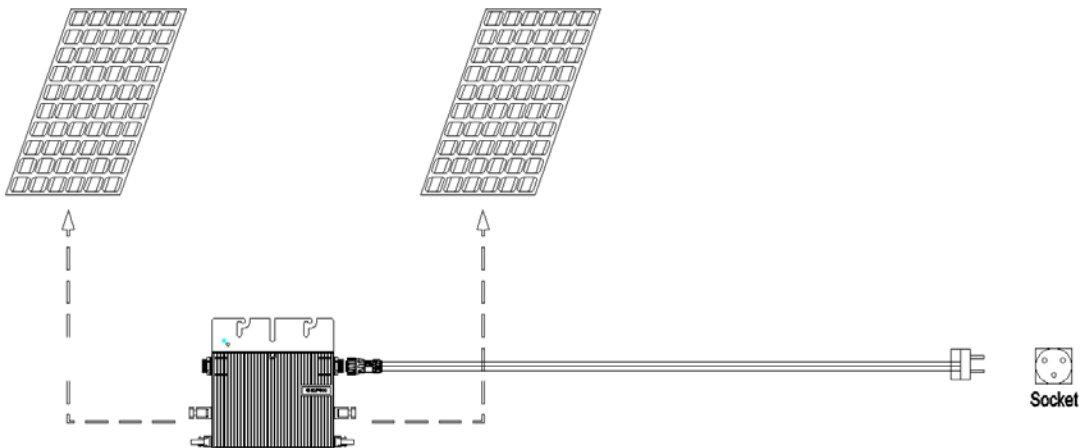

Fig.4. Assembly Illustration (Only one SMP600)

6.1.2. Assembly instruction

Step 1. Install Micro-inverter

Mark the approximate center of photovoltaic module on the frame and install the Micro-inverter with the LED side facing upwards.



The Micro-inverter must be under the module, out of long-term exposure to direct sunlight or rain.

First Type of Installation (Wall bracket hole):

There are two wall bracket holes in each Micro-inverter as shown in Fig.1 and Fig.2. Use a pair of screws and nuts to install the micro-inverter onto the bracket as shown in Fig.5.

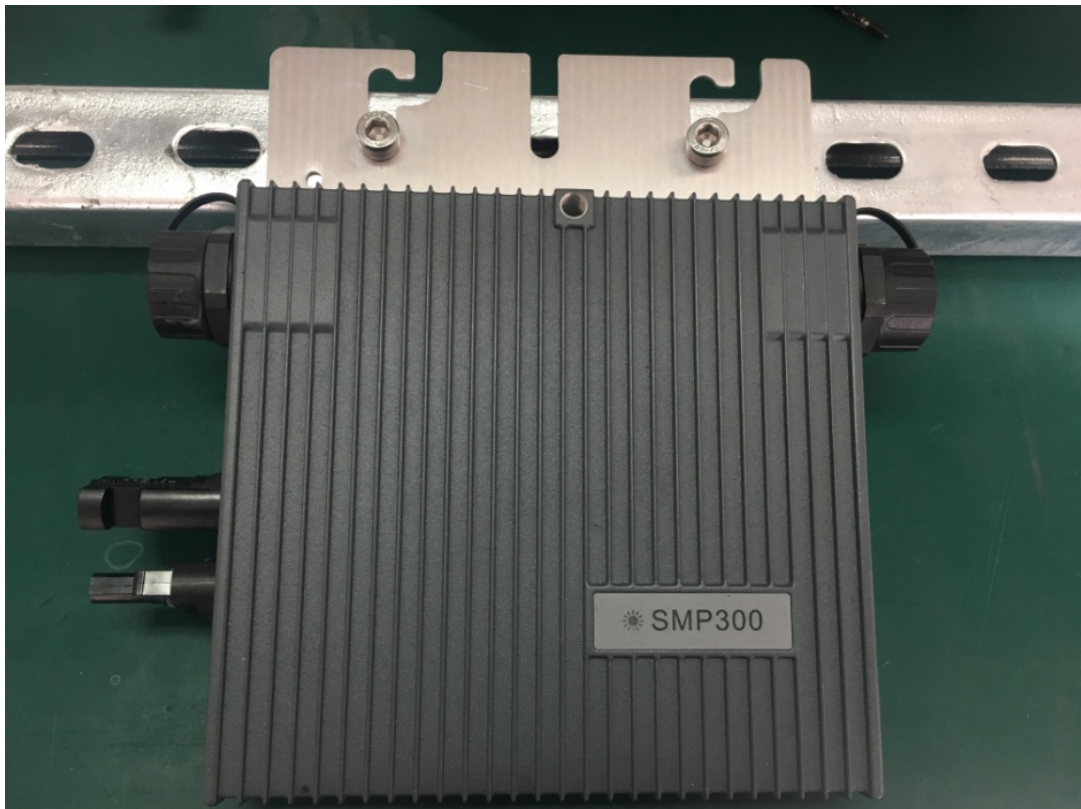

Fig.5. Installation Example (Wall Bracket Hole)

Second Type of Installation (Quick install hole):

There is a quick install hole in each Micro-inverter as shown in Fig.1 and Fig.2.

We provide a screw and a metal accessory as shown in Fig.6. Put them on the bracket as shown in Fig.7.



Fig.6. Screw and Accessory



Fig.7. Installation Position

Tighten the screw into the quick install hole on the backside of micro-inverter as shown in Fig.8. Finally finish the installation as shown in Fig.9.



Fig.8. Tighten the screw



Fig.9. Installation Example (Quick Install Hole)

Step 2. Connecting AC End Cables

Connect the AC end cables. We provide an AC connector for each micro-inverter as shown in Fig.10.



Fig.10. AC Connector

Separate the AC connector as shown in Fig.11.



Fig.11. Separate the AC connector

Use 12 AWG (4mm²) copper wire for AC end cables. Use only solid wire or stranded wire. The definition of the AC connector is shown in Fig.12.

Port 1(Brown/Red): Live
Port2(Yellow-Green): Ground
Port3(Blue/Black): Neutral

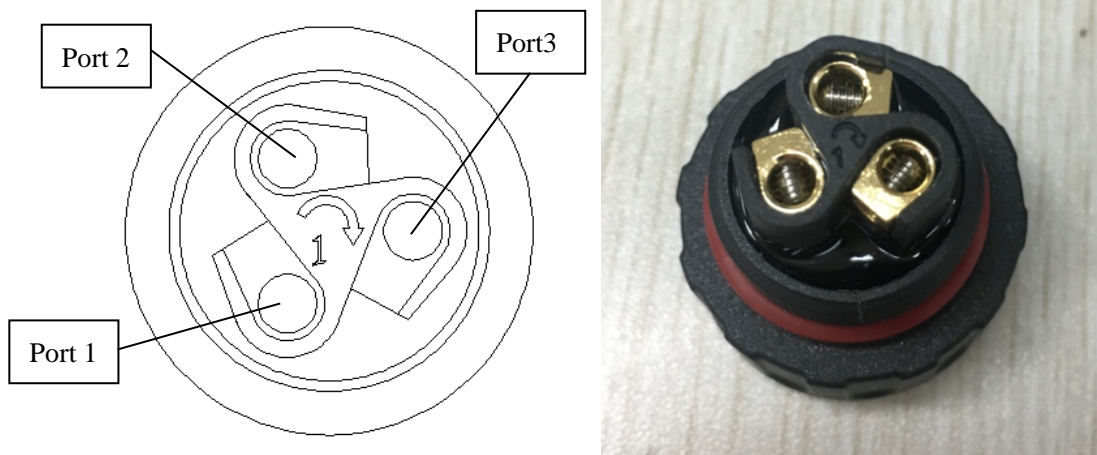

Fig.12. Definition of the AC connector

After finishing wiring ,reassemble the AC connector as shown in Fig.13.



Fig.13. Reassemble the AC connector

Open the protective cover of the connector as shown in Fig.14. Plug the AC connectors of the AC End Cable into the micro-inverter as shown in Fig.15. Make sure the protective cover of the unused AC connector to be closed.

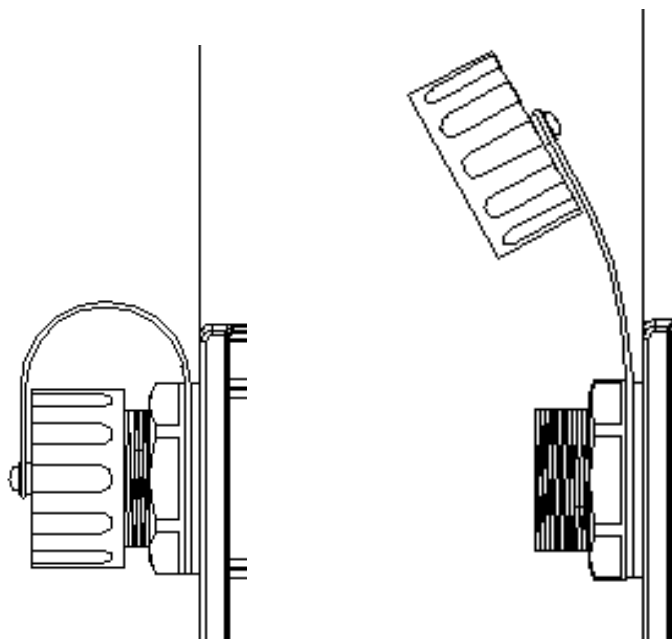

Fig.14. Open the protective cover of the connector

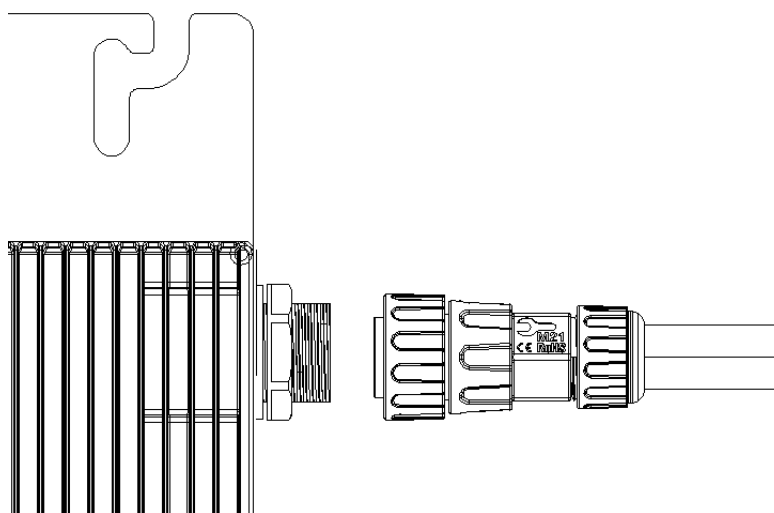

Fig.15. Connect AC Cable of Micro-inverter



WARNING

To prevent electrical hazards, all the connection operations must be carried out with the equipment disconnected from the grid.



WARNING

Pay special attention and ensure not to reverse the phase with the neutral!



WARNING

The installation technician is responsible for selecting a cable with the appropriate length and cross section.

Step 3. Install Photovoltaic Modules

Install the photovoltaic modules, and connect the DC cables of the modules to the corresponding DC input side of the Micro-inverter.

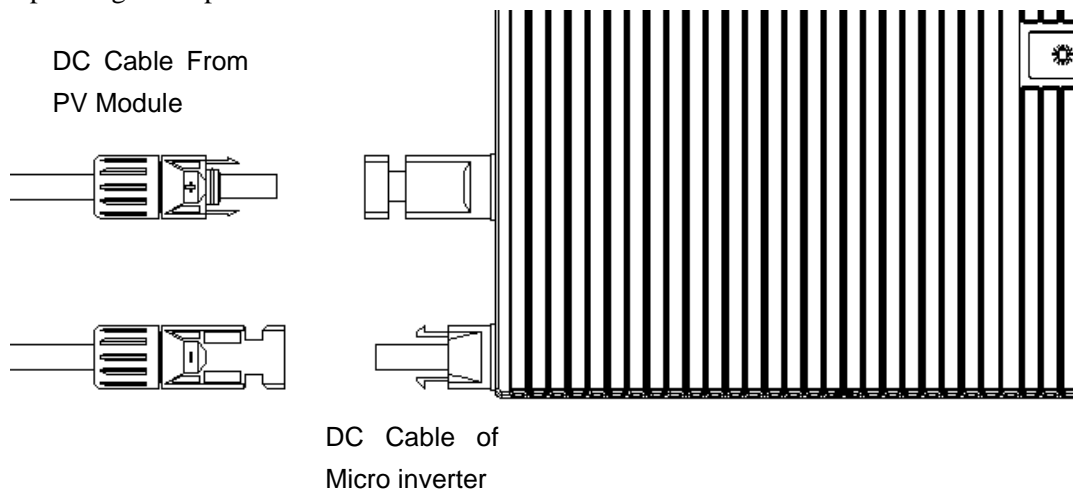

Fig.16. Connect DC Cables



The recommended installation needs keeping the Micro-inverters underneath the photovoltaic modules, so that the Micro-inverters can operate in the shade. Direct sunlight may cause damage to the Micro-inverters.



Each module must be connected to the Micro-inverters with a DC cable having a length of less than 3m.

Check the LED on the side of the micro-inverter. The LED flashes green and red at start up.

LED	Indicates
Flashing Green	Working properly. The higher efficiency is, the faster LED will flash.
Solid Red	Waiting for connecting to the power grid.

6.2. Install Several Micro-inverters

6.2.1. Installing diagram

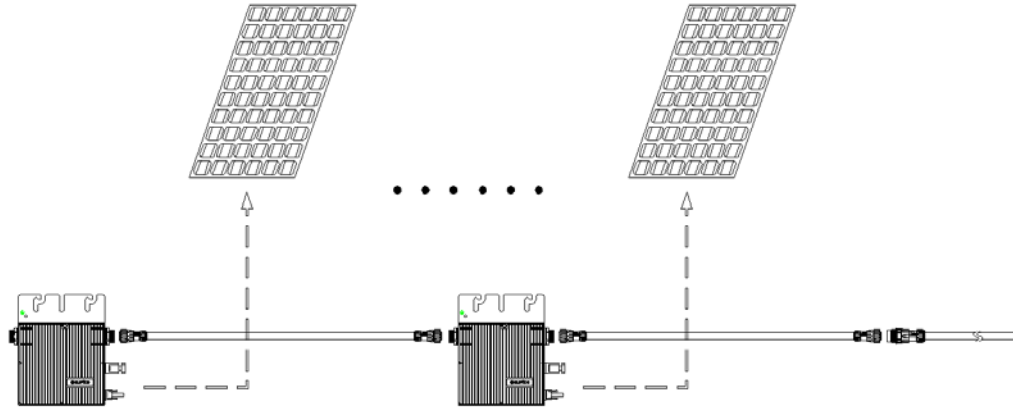

Fig.17. Assembly Illustration (Install SMP300 at Each cable section)

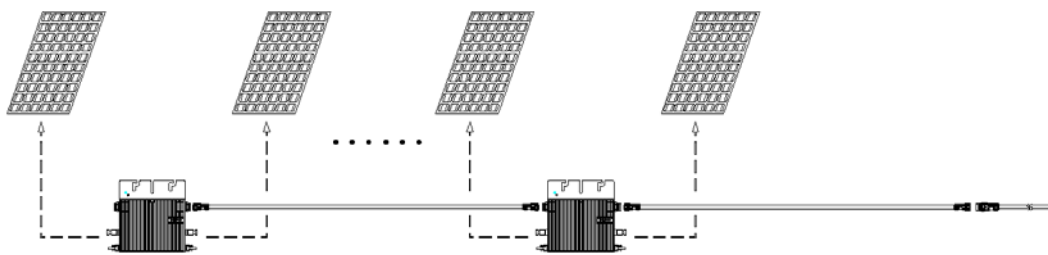

Fig.18. Assembly Illustration (Install SMP600 at Each cable section)

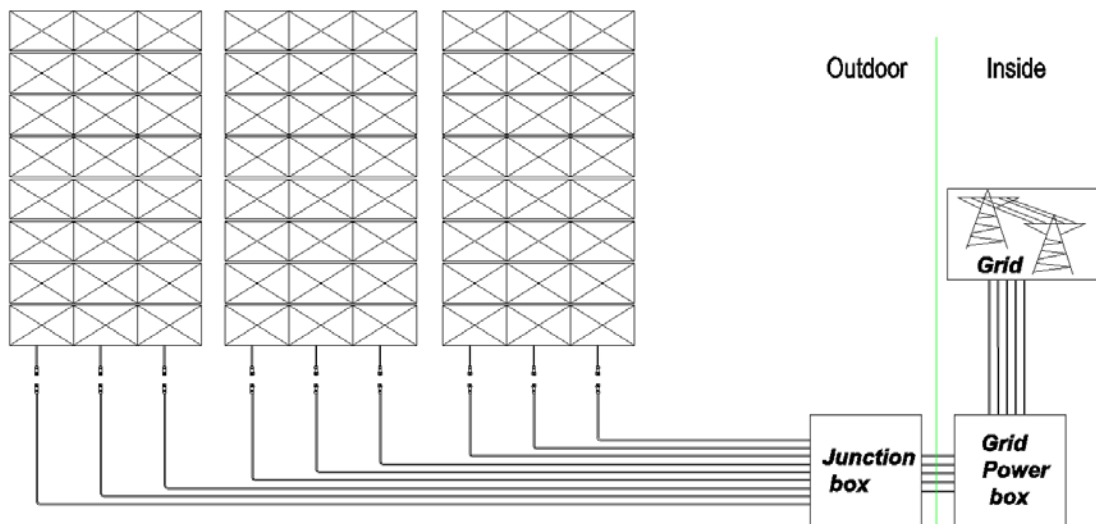

Fig.19. Assembly Illustration (Photovoltaic System)

6.2.2. Assembly instruction

Step 1. Install Micro-inverter

Mark the approximate center of each photovoltaic module on the frame and install the Micro-inverter with the LED side facing upwards.



Observe the certification documents concerning the maximum number of Micro- inverters permitted for installation at each cable section!

Type	Numbers for each cable section
SMP300	16
SMP600	8



The Micro-inverter must be under the module, out of long-term exposure to direct sunlight or rain.



Make sure the installation position of micro-inverter meet the requirements of AC cables.

Type	AC Cable
SMP300	1.1m
SMP600	2.1m

First Type of Installation (Wall bracket hole):

There are two wall bracket holes in each Micro-inverter as shown in Fig.1 and Fig.2. Use a pair of screws and nuts to install the micro-inverter onto the bracket as shown in Fig.20.

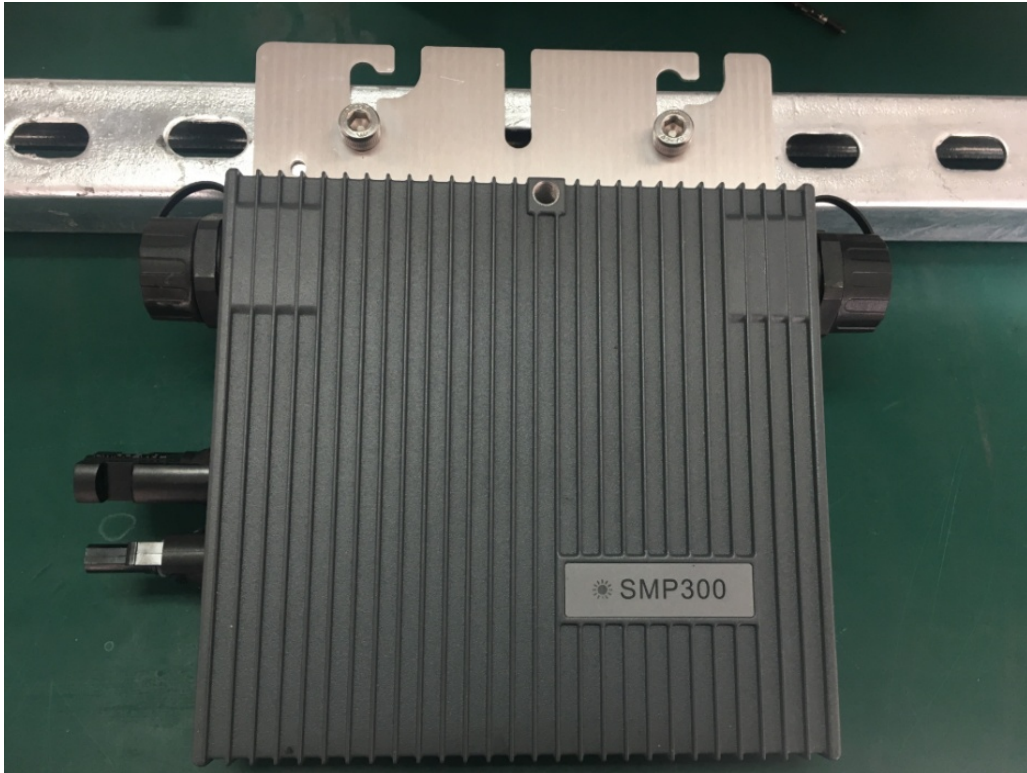

Fig.20. Installation Example (Wall Bracket Hole)

Second Type of Installation (Quick install hole):

There is a quick install hole in each Micro-inverter as shown in Fig.1 and Fig.2.

We provide a screw and a metal accessory as shown in Fig.21. Put them on the bracket as shown in Fig.22.



Fig.21. Screw and Accessory



Fig.22. Installation Position

Tighten the screw into the quick install hole on the backside of micro-inverter as shown in Fig.23. Finally finish the installation as shown in Fig.24.



Fig.23. Tighten the screw



Fig.24. Installation Example (Quick Install Hole)

Step 2. Install AC Junction Box

Install an junction box if needed.

Choose a suitable model of air-switch according to the limit current of each cable section.

Install a monitor device (SMPM100) and a PLC filter in the junction box if needed.

Provide an AC connection from the AC junction box back to the electricity network connection using equipment and practices as required by local jurisdictions.

Fig.25. Install AC Junction Box

Step 3. Connect AC Cable of Micro-inverter

Open the protective cover of the connector as shown in Fig.26. Plug the AC connectors of the AC Cable into two connectors of different micro-inverters to form a continuous AC branch circuit as shown in Fig.27. Make sure the protective cover of the unused AC connector to be closed. (Especially the last micro-inverter)

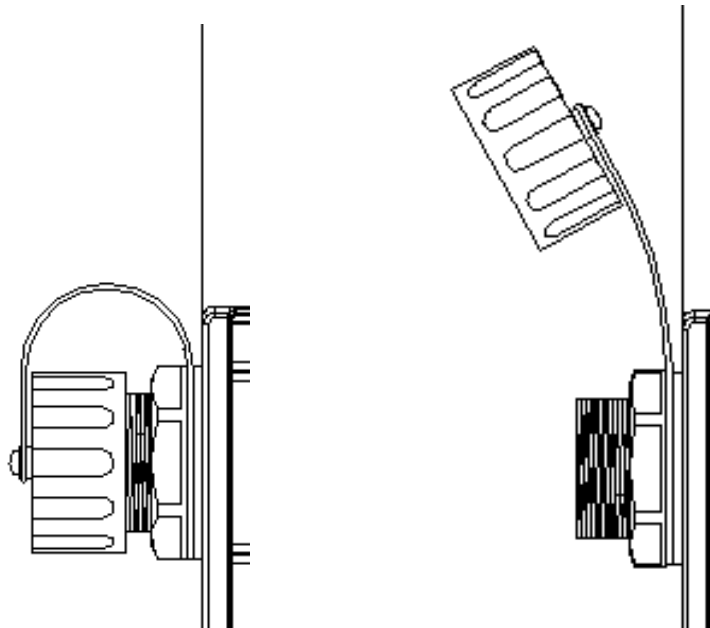

Fig.26. Open the protective cover of the connector

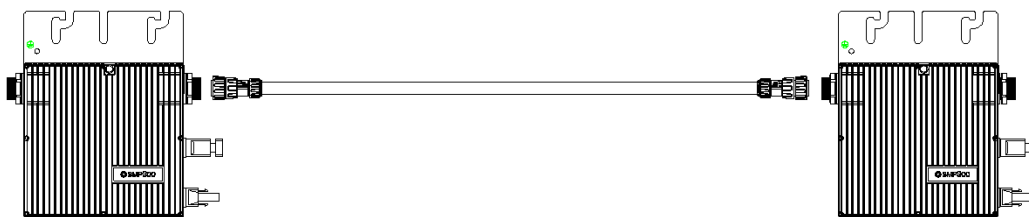

Fig.27. Connect AC Cable of Micro-inverter

Step 4. Connecting AC End Cables to Junction Box

Connect the AC end cables coming from each cable section to the junction box. We provide an AC connector with each micro-inverter as shown in Fig.28.



Fig.28. AC Connector

Separate the AC connector as shown in Fig.29.



Fig.29. Separate the AC connector

Use 12 AWG (4mm²) copper wire for AC end cables. Use only solid wire or stranded wire. The definition of the AC connector is shown in Fig.30.

- Port 1(Brown/Red): Live
- Port 2(Yellow-Green): Ground
- Port 3(Blue/Black): Neutral

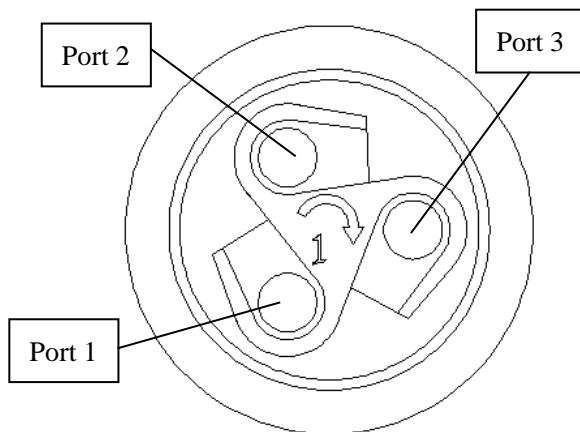

Fig.30. Definition of the AC connector

After finishing wiring ,reassemble the AC connector as shown in Fig.31.





Fig.31. Reassemble the AC connector



WARNING

To prevent electrical hazards, all the connection operations must be carried out with the equipment disconnected from the grid.



WARNING

All the external connections to the insulated junction box (caps, adapters, etc.) must be made with securely-sealed Omnik components.



WARNING

Pay special attention and ensure not to reverse the phase with the neutral! The installation technician is responsible for selecting a junction box with the appropriate dimensions and insulation.



WARNING

The installation technician is responsible for selecting a cable with the appropriate length and cross section.

Step 5. Create an Installation Map

Peel the removable serial number label from each micro-inverter. The position of the label is shown as below. The DC inputs of SMP600 are identified by A and B. The left input is A and the right one is B, shown as above.

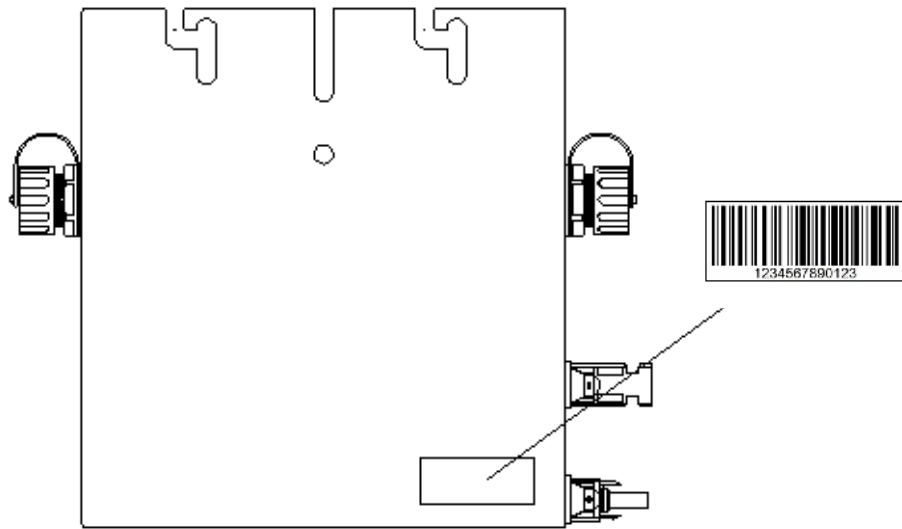

Fig.32. Serial Number Label (SMP300)

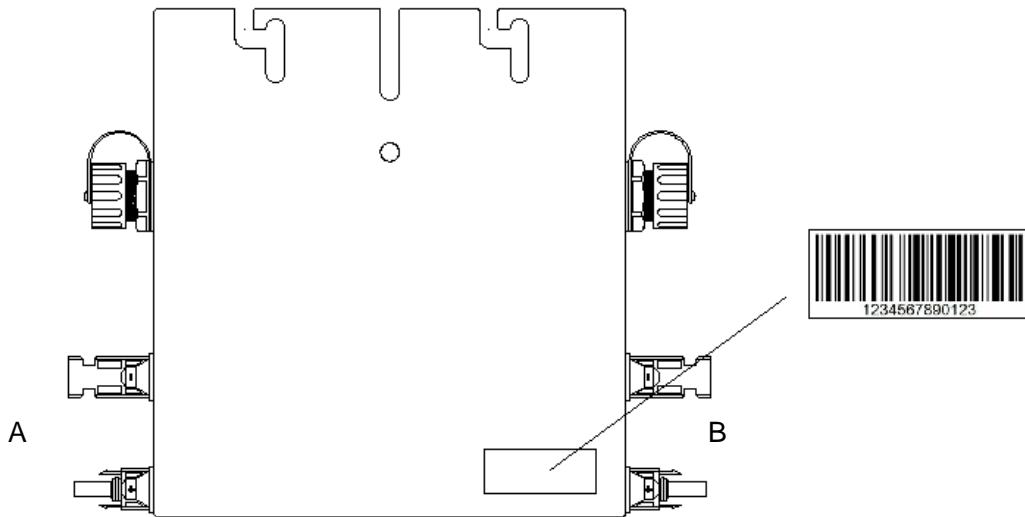

Fig.33. Serial Number Label (SMP600)

Affix the serial number label to the respective location on the installation map (found in the Appendix of this manual).



		Customer Information:		Please affix the extra label that comes from each inverter, on the appropriate position on this diagram.	
	1	2	3	4	5
A	A		B		
B					
C		A			
D		B			
E					

Fig.33. System Map (SMP600)

Step 6. Install Photovoltaic Modules

Install the photovoltaic modules, and connect the DC cables of the modules to the corresponding DC input side of the Micro-inverter.

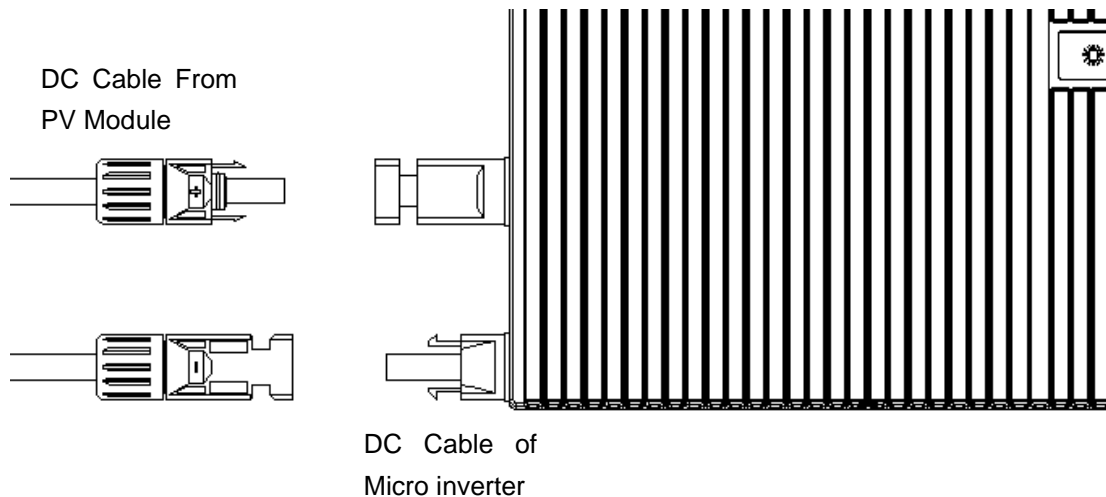

Fig.34. Connect DC Cables



The recommended installation needs keeping the Micro-inverters underneath the photovoltaic modules, so that the Micro-inverters can operate in the shade. Direct sunlight may cause damage to the Micro-inverters.



Each module must be connected to the Micro-inverters with a DC cable having a length of less than 3m.

Check the LED on the side of the micro-inverter. The LED flashes green and red at start up.

LED	Indicates
Flashing Green	Working properly. The higher efficiency is, the faster LED will flash.
Solid Red	Waiting for connecting to the power grid.

Step 7. Energize the System

If applicable, turn on the AC disconnect or circuit breaker for the branch circuit. Turn on the main utility-grid AC circuit breaker. Your system will start producing power after about a two-minute wait time.

7. Maintenance guide

7.1. Routine maintenance

- Only authorized personnel are allowed to carry out the maintenance operations and are responsible to report any anomalies.
- Always use the personal protective equipment provided by the employer when carry out the maintenance operation.
- During normal operation, check that the environmental and logistic conditions are correct. Make sure that the conditions have not changed over time and that the equipment is not exposed to adverse weather conditions and has not been covered with foreign bodies.
- DO NOT use the equipment if any problems are found, and restore the normal conditions after the fault removed.
- Conduct an annual inspection on various components, and clean the equipment with a vacuum cleaner or special brushes.
- Firmware version can be queried by monitoring system.



Do not attempt to dismantle the Micro-inverter or make any internal repairs! In order to preserving the integrity of safety and insulation, the Micro-inverters are not designed to allow internal repairs!



Maintenance operations must be carried out with the equipment disconnected from the grid (power switch open) and the photovoltaic modules obscured or isolated, unless otherwise indicated.



For cleaning, DO NOT use rags made of filamentary material or corrosive products that may corrode parts of the equipment or generate electro static charges.



Avoid temporary repairs. All repairs should be carried out using only genuine spare parts.

7.2.Storage and dismantling

- If the equipment is not used immediately or is stored for long periods, check that it is correctly packed. The equipment must be stored in well-ventilated indoor areas that do not have characteristics that might damage the components of the equipment.
- Take a complete inspection when restarting after a long time or prolonged stop.
- Please dispose the equipment properly after scrapping, which are potentially harmful to the environment, in accordance with the regulations in force in the country of installation.

8. Contact Information

Omnik New Energy Co.,Ltd.(Headquarters)

Address: Third Floor,Building 3,No.63 Weixin Road,SIP,Suzhou,China

Tel: +86-512-6956-8216

Fax: +86-512-6295-6682

E-mail: sales@omnik-solar.com

sevice@omnik-solar.com

Website: www.omniksolar.com

Omnik German branch

Address: Omnik Gmbh Forsthausstr.8A 65479 Raunheim

Tel: +49(0) 1799762654

Mobile: +49(176) 30743149

E-mail: jingjing.zhang@omnik-solar.com

Omnik UK Service Partner

Address: 3 More London Riverside SE1 2RE,London

Tel: +86 512 69568216 8833

E-mail: Frank.Liu@omnik-solar.com

OmnikItaly Srl

Address: Via Francesco Baracca, 500043 Ciampino(Roma)

Tel: +39 06 211.26.522

Fax: +39 06 565.616.46

E-mail: info@omniksolar.it

Website: www.omniksolar.it

Omnik Netherlands Office

Address: Goudstraat 65,2718RD Zoetermeer, The Netherlands

Tel: +31 30265 7845

E-mail: lena.wang@omnik-solar.com

Appendix : TEMPLATE FOR MAP OF MICRO-INVERTER INSTALLATION

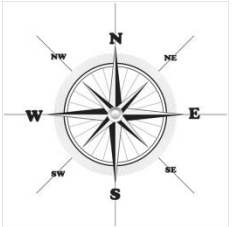
	Customer Information:		Please affix the extra label that comes from each inverter, on the appropriate position on this diagram.		
	1	2	3	4	5
A					
B					
C					
D					
E					